

# 5kHz, 400nA, Rail-to-Rail I/O CMOS Operational Amplifier

## FEATURES

- **GAIN BANDWIDTH:** 5kHz
- **RAIL-TO-RAIL INPUT AND OUTPUT**  
0.5mV Typical Vos
- **INPUT VOLTAGE RANGE:** -0.1V to +5.6V  
with Vs = 5.5V
- **SUPPLY RANGE:** +1.4V to +5.5V
- **SPECIFIED UP TO +125°C**
- **MicroSIZE PACKAGES:** SOT23-5

## APPLICATIONS

- **SENSORS**
- **PHOTODIODE AMPLIFICATION**
- **WEARABLE PRODUCTS**
- **TEMPERATURE MEASUREMENT**
- **BATTERY POWERED SYSTEM**

## DESCRIPTION

The RS8021, RS8022, RS8024, families of products offer low voltage operation and rail-to-rail input and output, as well as excellent speed/power consumption ratio, providing an excellent bandwidth (5kHz) and slew rate of 1.5V/ms. The op-amps are unity gain stable and feature an ultra-low input bias current.

The devices are ideal for sensor interfaces, active filters and portable applications. The RS8021, RS8022, RS8024 families of operational amplifiers are specified at the full temperature range of -40°C to +125°C under single or dual power supplies of 1.4V to 5.5V.

## PIN CONFIGURATIONS

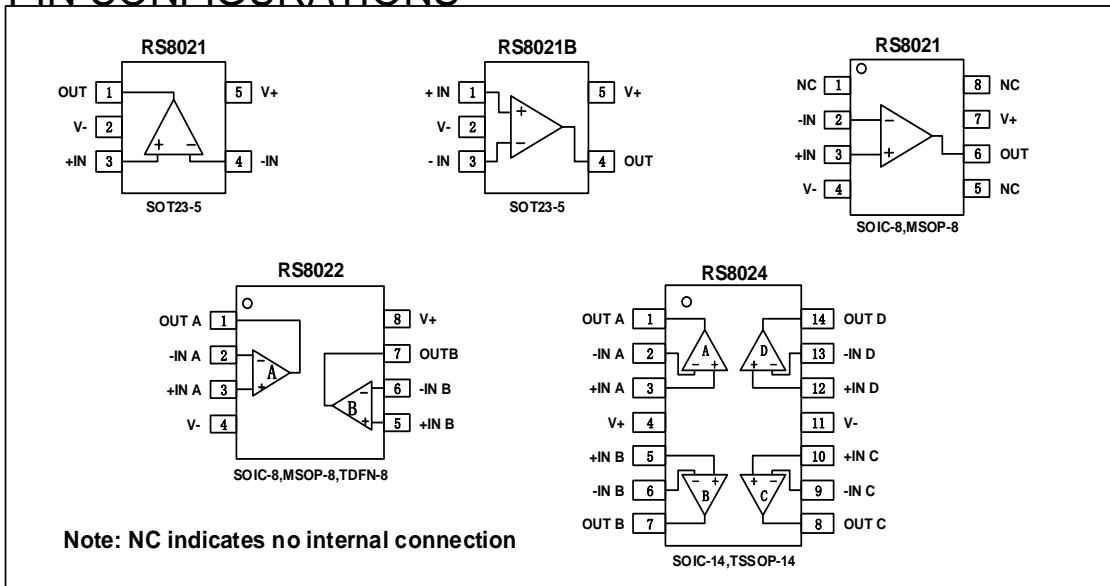

**ABSOLUTE MAXIMUM RATINGS <sup>(1)</sup>**

Supply Voltage, V+ to V-	7.0V
Input Terminals, Voltage <sup>(2)</sup>	- 0.5 to (V+) + 0.5V
Current <sup>(2)</sup>	±10mA
Storage Temperature	-65°C to +150°C
Operating Temperature	-40°C to +125°C
Junction Temperature	150°C
Package Thermal Resistance @ T <sub>A</sub> = +25°C	
SOT23-5, SOT23-6	200°C/W
MSOP-10, SOIC-8	150°C/W
SOIC-14, TSSOP-14	100°C/W
Lead Temperature (Soldering, 10s)	260°C
ESD Susceptibility	
HBM	5000V
MM	400V

**ESD SENSITIVITY CAUTION**

ESD damage can range from subtle performance degradation to complete device failure. Precision integrated circuits may be more susceptible to damage because very small parametric changes could cause the device not to meet its published specifications.

(1) Stresses above these ratings may cause permanent damage. Exposure to absolute maximum conditions for extended periods may degrade device reliability. These are stress ratings only, and functional operation of the device at these or any other conditions beyond those specified is not implied.

(2) Input terminals are diode-clamped to the power-supply rails. Input signals that can swing more than 0.5V beyond the supply rails should be current-limited to 10mA or less.

**PACKAGE/ORDERING INFORMATION**

PRODUCT	ORDERING NUMBER	TEMPERATURE RANGE	PACKAGE LEAD	PACKAGE MARKING	PACKAGE OPTION
RS8021	RS8021XK	-40°C~125°C	SOIC-8	RS8021	Tape and Reel,2500
	RS8021XF	-40°C~125°C	SOT23-5	8021	Tape and Reel,3000
	RS8021BXF	-40°C~125°C	SOT23-5	8021B	Tape and Reel,3000
	RS8021XM	-40°C~125°C	MSOP-8	RS8021	Tape and Reel,3000
RS8022	RS8022XK	-40°C~125°C	SOIC-8	RS8022	Tape and Reel,2500
	RS8022XM	-40°C~125°C	MSOP-8	RS8022	Tape and Reel,3000
	RS8022XT	-40°C~125°C	TDFN-8	RS8022	Tape and Reel,3000
RS8024	RS8024XP	-40°C~125°C	SOIC -14	RS8024	Tape and Reel,2500
	RS8024XQ	-40°C~125°C	TSSOP-14	RS8024	Tape and Reel,3000

**ELECTRICAL CHARACTERISTICS**

 (At  $T_A = +25^\circ\text{C}$ ,  $V_S = 5.0\text{V}$ ,  $R_L = 1\text{M}\Omega$  connected to  $V_S/2$ , and  $V_{OUT} = V_S/2$ , unless otherwise noted.)

PARAMETER		CONDITIONS	RS8021,RS8022,RS8024			UNITS
			MIN	TYP	MAX	
<b>POWER SUPPLY</b>						
$V_S$	Operating Voltage Range		1.4		5.5	V
$I_Q$	Quiescent Current/Amplifier			400	1000	nA
PSRR	Power-Supply Rejection Ratio	$V_S = 2.5\text{V to } 5.5\text{V}$ , $V_{cm} = (V_-) + 0.5\text{V}$	62	70		dB
<b>INPUT</b>						
$V_{os}$	Input Offset Voltage	$V_{cm} = V_S/2$		0.5	3	mV
$\Delta V_{os}/\Delta T$	Input Offset Voltage Drift	$V_{cm} = V_S/2$ , $-40^\circ\text{C} \leq T_A \leq 125^\circ\text{C}$		2.3		$\mu\text{V}/^\circ\text{C}$
$I_B$	Input Bias Current			1	10	pA
$I_{os}$	Input Offset Current			1	10	pA
$V_{cm}$	Common-Mode Voltage Range	$V_S = 5.5\text{V}$	-0.1		5.6	V
CMRR	Common-Mode Rejection Ratio	$V_S = 5.5\text{V}$ , $V_{cm} = -0.1\text{V to } 4\text{V}$	73	90		dB
		$V_S = 5.5\text{V}$ , $V_{cm} = -0.1\text{V to } 5.6\text{V}$	60	83		dB
<b>OUTPUT</b>						
AOL	Open-Loop Voltage Gain	$V_S = 1.4\text{V}$ , $R_L = 50\text{k}\Omega$ , $V_o = V_S - 0.1\text{V}$	85	102		dB
		$V_S = 5.0\text{V}$ , $R_L = 50\text{k}\Omega$ , $V_o = V_S - 0.1\text{V}$	92	106		dB
	Output Swing From Rail	$R_L = 50\text{k}\Omega$		5		mV
$I_{out}$	Output Short-Circuit Current			8		mA
<b>FREQUENCY RESPONSE</b>						
SR	Slew Rate			1.5		V/ms
GBP	Gain-Bandwidth Product			5		kHz
PM	Phase Margin			60		$^\circ$
<b>NOISE</b>						
$e_{n\text{p-p}}$	Input Voltage Noise	$f = 0.1\text{ Hz to } 10\text{ Hz}$		4.5		$\mu\text{Vpp}$
$e_n$	Input Voltage Noise Density	$f = 1\text{ kHz}$		360		$\text{nV}/\sqrt{\text{Hz}}$

**TYPICAL CHARACTERISTICS**

At  $T_A = +25^\circ\text{C}$ ,  $V_S = 5\text{V}$ ,  $R_L = 1\text{M}\Omega$  connected to  $V_S/2$ ,  $C_L = 60\text{pF}$ ,  $V_{CM} = V_S/2$ , unless otherwise noted.

SMALL-SIGNAL STEP RESPONSE

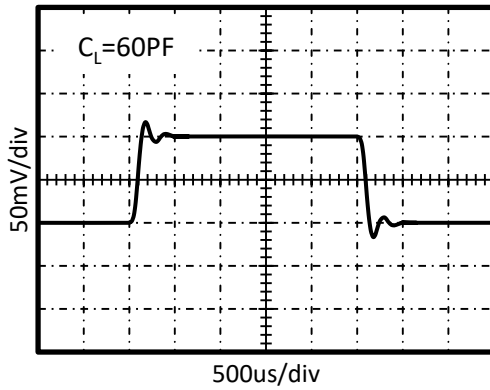

SMALL-SIGNAL STEP RESPONSE

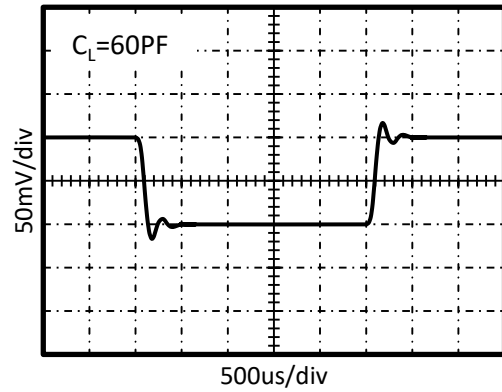

LARGE-SIGNAL STEP RESPONSE

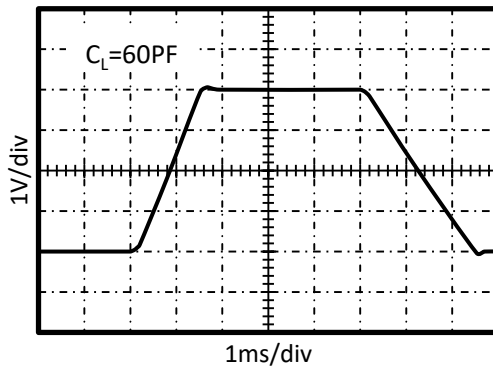

LARGE-SIGNAL STEP RESPONSE

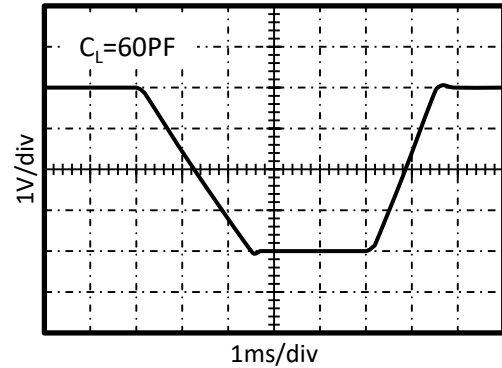

SINK CURRENT vs TEMPERATURE

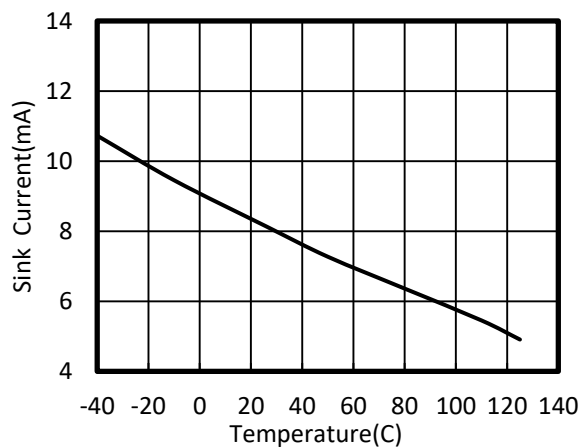

SOURCE CURRENT vs TEMPERATURE

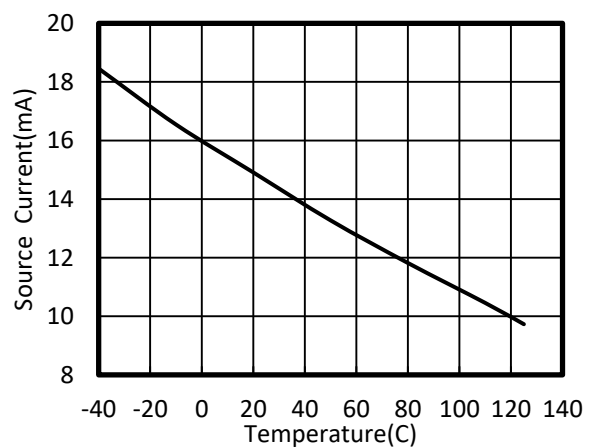

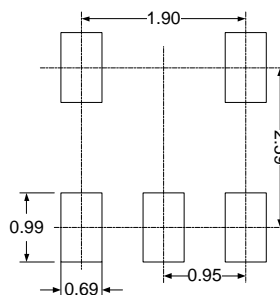
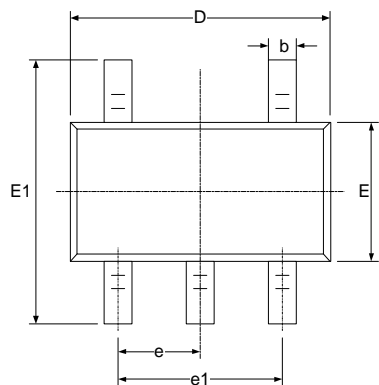
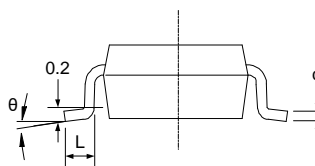
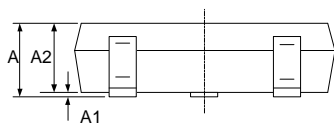
**PACKAGE OUTLINE DIMENSIONS**
**SOT23-5**

**RECOMMENDED LAND PATTERN (Unit: mm)**

Symbol	Dimensions In Millimeters		Dimensions In Inches	
	Min	Max	Min	Max
A	1.050	1.250	0.041	0.049
A1	0.000	0.100	0.000	0.004
A2	1.050	1.150	0.041	0.045
b	0.300	0.500	0.012	0.020
c	0.100	0.200	0.004	0.008
D	2.820	3.020	0.111	0.119
E	1.500	1.700	0.059	0.067
E1	2.650	2.950	0.104	0.116
e	0.950(BSC)		0.037(BSC)	
e1	1.800	2.000	0.071	0.079
L	0.300	0.600	0.012	0.024
$\theta$	0°	8°	0°	8°

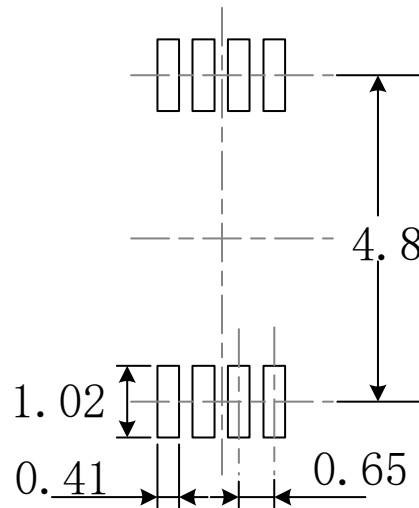
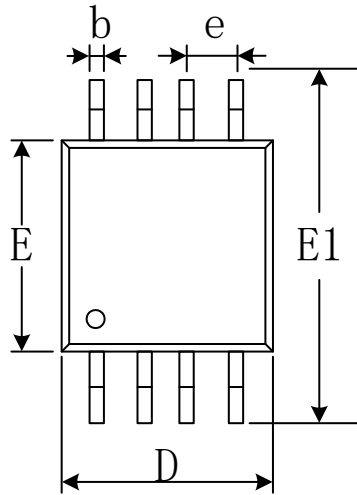
# MSOP-8

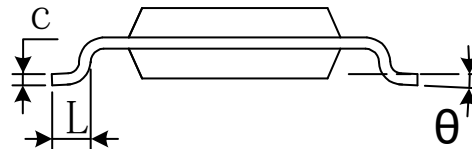
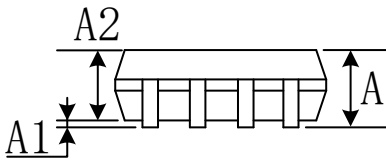

RECOMMENDED LAND PATTERN (Unit: mm)



Symbol	Dimensions In Millimeters		Dimensions In Inches	
	Min	Max	Min	Max
A	0.820	1.100	0.032	0.043
A1	0.020	0.150	0.001	0.006
A2	0.750	0.950	0.030	0.037
b	0.250	0.380	0.010	0.015
c	0.090	0.230	0.004	0.009
D	2.900	3.100	0.114	0.122
e	0.650(BSC)		0.026(BSC)	
E	2.900	3.100	0.114	0.122
E1	4.750	5.050	0.187	0.199
L	0.400	0.800	0.016	0.031
$\theta$	0°	6°	0°	6°

# TSSOP-14

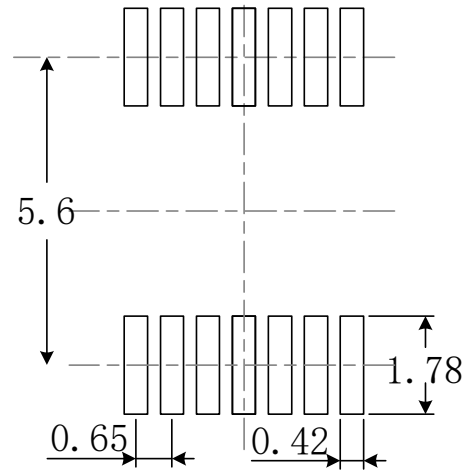
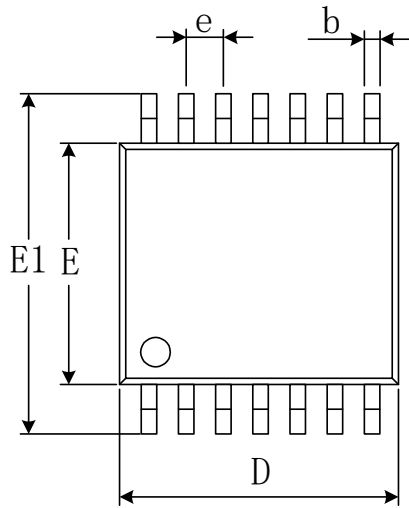

RECOMMENDED LAND PATTERN (Unit: mm)

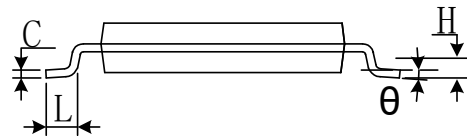
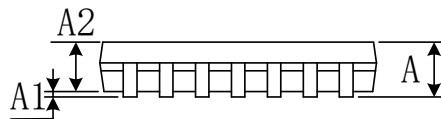

Symbol	Dimensions In Millimeters		Dimensions In Inches	
	Min	Max	Min	Max
A		1.200		0.047
A1	0.050	0.150	0.002	0.006
A2	0.800	1.050	0.031	0.041
b	0.190	0.300	0.007	0.012
c	0.090	0.200	0.004	0.008
D	4.860	5.100	0.191	0.201
E	4.300	4.500	0.169	0.177
E1	6.250	6.550	0.246	0.258
e	0.650(BSC)		0.026(BSC)	
L	0.500	0.700	0.020	0.028
H	0.25(TYP)		0.01(TYP)	
$\theta$	1°	7°	1°	7°

# SOIC-8

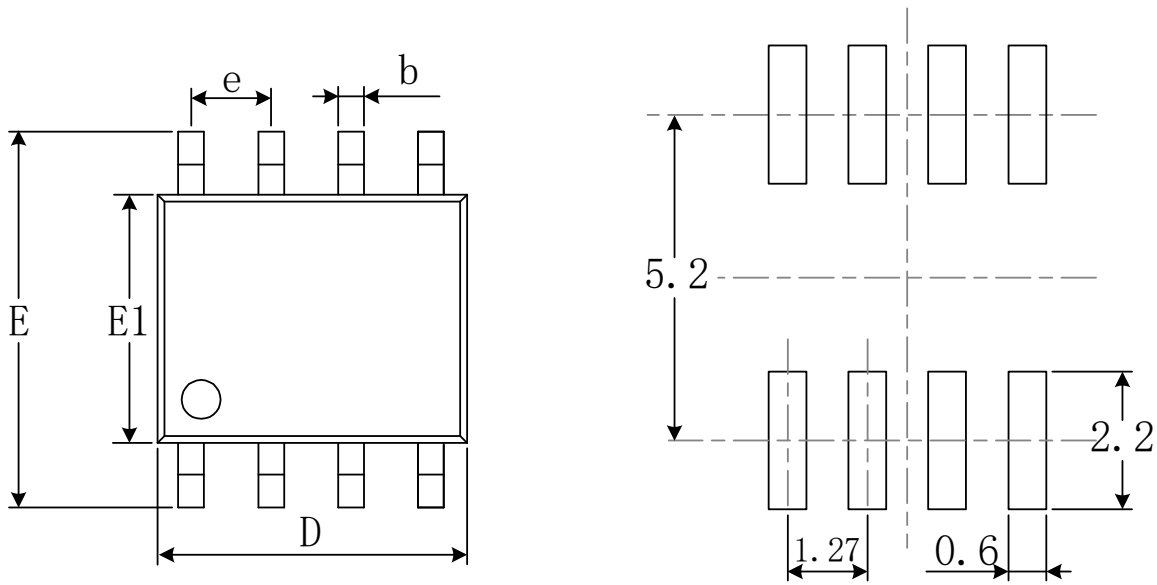

RECOMMENDED LAND PATTERN (Unit: mm)

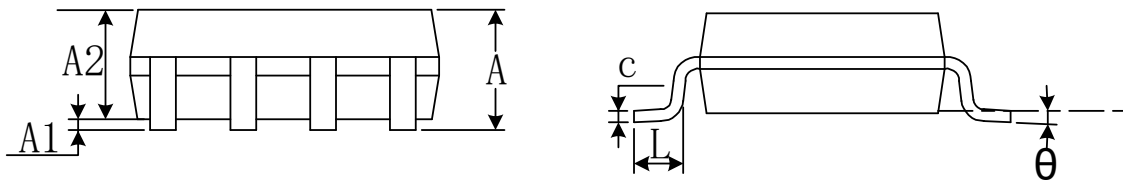

Symbol	Dimensions In Millimeters		Dimensions In Inches	
	Min	Max	Min	Max
A	1.350	1.750	0.053	0.069
A1	0.100	0.250	0.004	0.010
A2	1.350	1.550	0.053	0.061
b	0.330	0.510	0.013	0.020
c	0.170	0.250	0.007	0.010
D	4.800	5.000	0.189	0.197
e	1.270(BSC)		0.050(BSC)	
E	5.800	6.200	0.228	0.244
E1	3.800	4.000	0.150	0.157
L	0.400	1.270	0.016	0.050
$\theta$	0°	8°	0°	8°



# SOIC-14

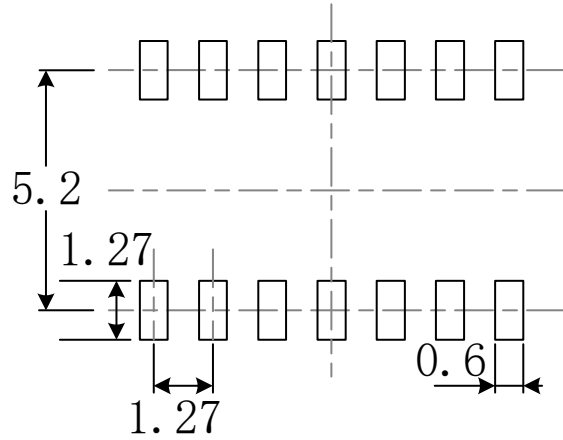
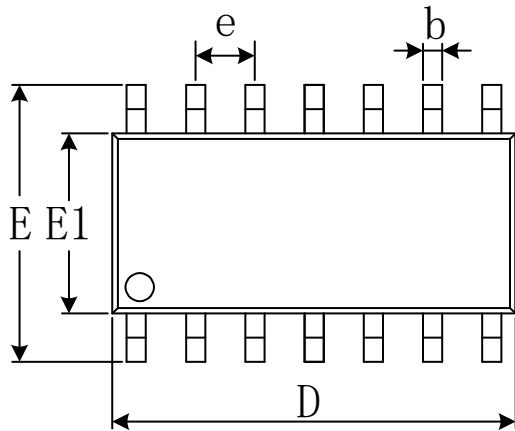

RECOMMENDED LAND PATTERN (Unit: mm)

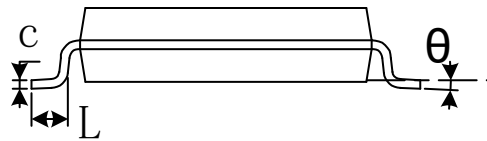
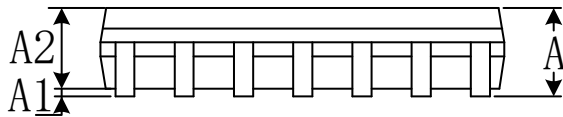

Symbol	Dimensions In Millimeters		Dimensions In Inches	
	Min	Max	Min	Max
A	1.350	1.750	0.053	0.069
A1	0.100	0.250	0.004	0.010
A2	1.350	1.550	0.053	0.061
b	0.310	0.510	0.012	0.020
c	0.100	0.250	0.004	0.010
D	8.450	8.850	0.333	0.348
e	1.270(BSC)		0.050(BSC)	
E	5.800	6.200	0.228	0.244
E1	3.800	4.000	0.150	0.157
L	0.400	1.270	0.016	0.050
$\theta$	0°	8°	0°	8°

# TDFN-3x3-8L

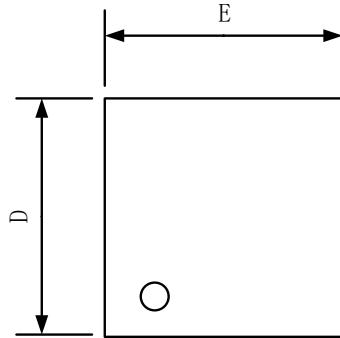

TOP VIEW

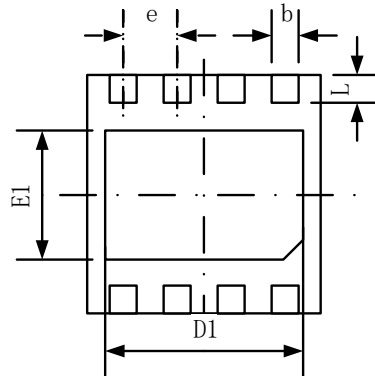

BOTTOM VIEW

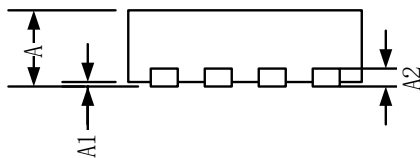

SIDE VIEW

Symbol	Dimensions In Millimeters		Dimensions In Inches	
	Min	Max	Min	Max
A	0.700	0.800	0.028	0.031
A1	0.000	0.050	0.000	0.002
A2	0.203		0.008	
b	0.300	0.400	0.012	0.016
D	2.900	3.100	0.114	0.122
D1	2.510	2.610	0.099	0.103
E	2.900	3.100	0.114	0.122
E1	1.550	1.650	0.061	0.065
e	0.650 TYP		0.026 TYP	
L	0.350	0.450	0.014	0.018