

# DIO6912

## High-Efficiency 2A Continuous, 2.5A Peak, 24V Input Synchronous Step Down Converter

### Features

- Low  $R_{DS(ON)}$  for internal switches (top/bottom) 130m $\Omega$ /90m $\Omega$ , 2.0A DC current
- 4.5-24V input voltage range
- High-Efficiency Synchronous-Mode
- Internal soft start limits the inrush current
- Over Current protection
- Thermal shutdown
- Green package:  
SOT23-6 is pin compatible.

### Descriptions

The DIO6912 is high-efficiency, high frequency synchronous step-down DC-DC regulator ICs capable of delivering up to 2A continuous output currents. The DIO6912 operates over a wide input voltage range from 4.5V to 24V and integrate main switch and synchronous switch with very low  $R_{DS(ON)}$  to minimize the conduction loss.

DIO6912 adopts the COT architecture to achieve fast transient responses for high step down applications and high efficiency at light loads. In addition, it operates at pseudo-constant frequency of 500kHz under heavy load conditions to minimize the size of inductor and capacitor.

### Applications

- Portable Navigation Device
- Set Top Box
- Portable TV
- LCD TV

### Function Block

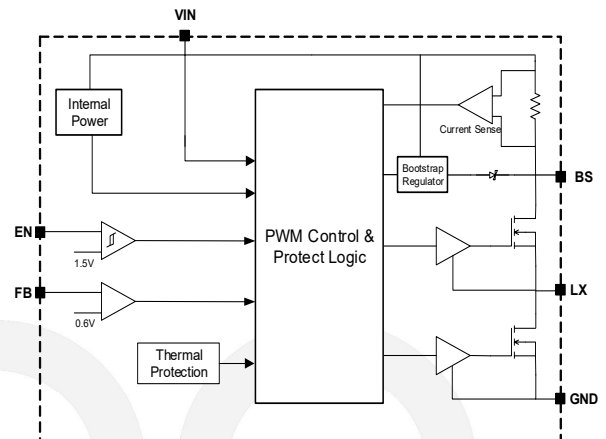

### Ordering Information

Order Part Number	Top Marking		$T_A$	Package	
DIO6912ST6	12YW	Green	-40 to +85°C	SOT23-6	Tape & Reel, 3000

## Pin Assignments

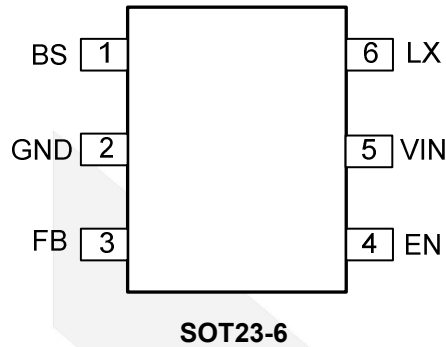

**Figure 1 Pin Assignment (Top View)**

## Pin Definitions

Pin Name	Description
BS	Bootstrap. Connect a capacitor and a resistor between SW and BS pins to form a floating supply across the high-side switch driver. Recommend to use 0.1μF BS capacitor.
GND	Power Ground
FB	Output Feedback Pin. Connect this pin to the center point of the output resistor divider (as shown in Figure 1) to program the output voltage: $V_{OUT}=0.6*(1+R1/R2)$ . Add optional C2 (10pF~47pF) to speed up the transient response.
EN	Enable control. Pull high to turn on. Do not float.
VIN	Power Input
LX	Inductor pin. Connect this pin to the switching node of inductor.



# DIO6912

High-Efficiency 2A Continuous, 2.5A Peak, 24V Input Synchronous Step Down Converter

## Absolute Maximum Ratings

Stresses beyond those listed under “Absolute Maximum Rating” may cause permanent damage to the device. These are stress ratings only and functional operation of the device at these or any other condition beyond those indicated in the operational sections of the specifications is not implied. Exposure to absolute maxim rating conditions for extended periods may affect device reliability.

Parameter		Rating	Unit
Supply Voltage ( V+ – V-)		28	V
EN, LX Voltage		-0.3 to V <sub>IN</sub> +0.3	V
FB Voltage		-0.3 to 6	V
BS Voltage		-0.3 to LX +6	V
LX(15ns transient) Voltage		-5 to 30	V
Power Dissipation, P <sub>D</sub> @ T <sub>A</sub> = 25°C, SOT23-6		0.6	W
Package Thermal Resistance	θ <sub>JA</sub>	170	°C/W
	θ <sub>JC</sub>	130	
Storage Temperature Range		-65 to 150	°C
Junction Temperature Range		150	°C
Lead Temperature Range		260	°C
HBM ESD, JESD22-A114	VIN Pin	±1	kV
	Other Pins	±2	

## Recommend Operating Conditions

The Recommended Operating Conditions table defines the conditions for actual device operation. Recommended Operating conditions are specified to ensure optimal performance to the datasheet specifications. DIOO does not Recommend exceeding them or designing to Absolute Maximum Ratings.

Parameter	Rating	Unit
Supply Voltage	4.5 to 24	V
Junction Temperature Range	-40 to 125	°C
Ambient Temperature Range	-40 to 85	°C



# DIO6912

High-Efficiency 2A Continuous, 2.5A Peak, 24V Input Synchronous Step Down Converter

## Electrical Characteristics

$V_{IN} = 12V$ ,  $V_{OUT} = 1.2V$ ,  $L = 2.2\mu H$ ,  $C_{OUT} = 22\mu F$ ,  $T_A = 25^\circ C$ ,  $I_{OUT}=1A$  unless otherwise specified.

Symbol	Parameter	Test Conditions	Min	Typ	Max	Unit
$V_{IN}$	Input Voltage Range		4.5		24	V
$I_Q$	Quiescent Current	$I_{OUT}=0$ , $V_{FB}=V_{REF} \cdot 105\%$		140		$\mu A$
$I_{SHDN}$	Shutdown Current	EN=0		5	10	$\mu A$
$V_{REF}$	Feedback Reference Voltage		0.588	0.6	0.612	V
$I_{FB}$	FB Input Current	$V_{FB}=V_{IN}$	-50		50	nA
$R_{DS(ON)1}$	Top FET $R_{ON}$			130		m $\Omega$
$R_{DS(ON)2}$	Bottom FET $R_{ON}$			90		m $\Omega$
$I_{LIM}$	Bottom FET Valley Current Limit		2.7			A
$V_{ENH}$	EN Rising Threshold		1.5			V
$V_{ENL}$	EN Falling Threshold				0.4	V
UVLOH	Under Voltage Lock Out High			4.2	4.5	V
UVLOL	Under Voltage Lock Out Low			3.8	4	V
$f_{SW}$	Switching Frequency			500		kHz
$T_{ON}$	ON Time	$V_{IN} = 12V$ , $V_{OUT} = 1.2V$ , $I_{OUT}=1A$		200		ns
	Min ON Time			50		ns
	Min OFF Time			100		ns
$T_{SS}$	Soft Start Time			1		ms
$T_{SD}$	Thermal Shutdown Temperature			150		$^\circ C$
$T_{HYS}$	Thermal Shutdown Hysteresis			15		$^\circ C$

Specifications subject to change without notice.

### Typical Application

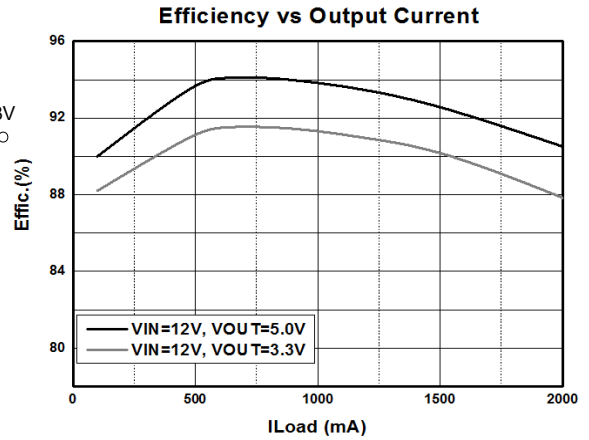
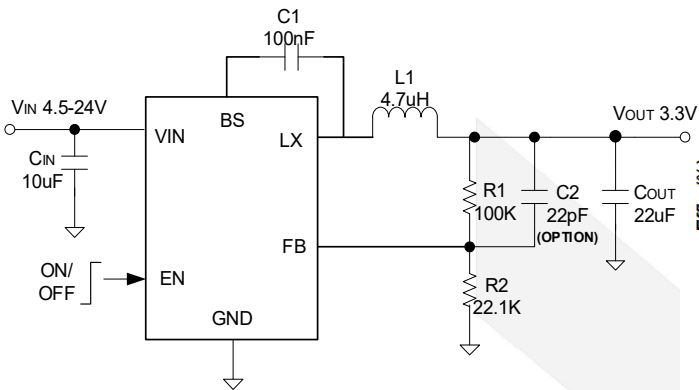

### DIO6912 Recommended Table:

V <sub>OUT</sub> (V)	R2(kΩ)	C2(pF)	L1/ Partnumber
1	150	Null	2.2μH/ SWPA4020S2R2NT (VLC60465T-2R2N)
1.2	100	Null	2.2μH/ SWPA4020S2R2NT (VLC60465T-2R2N)
1.8	49.9	Null	3.3μH/ SWPA6028S3R3NT (VLC60465T-3R3N)
2.5	31.6	Null	3.3μH/ SWPA6028S3R3NT (VLC60465T-3R3N)
3.3	22.1	22 (option)	4.7μH/ SWPA5040S4R7NT (VLC60465T-4R7M)
5	13.7	22 (option)	6.8μH/ SWPA6045S6R8MT (VLC60465T-6R8M)

### Typical Performance Characteristics

**Start up from Enable**  
(VIN=12V, VOUT=3.3V, Load=1.5Ω)

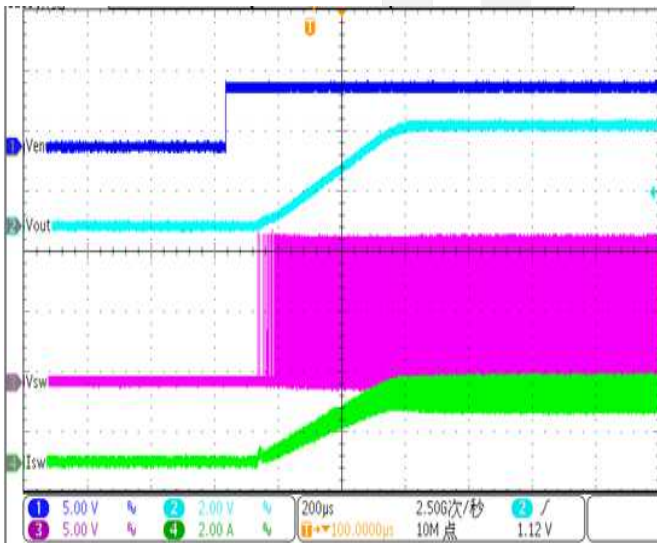

**Shut down from Enable**  
(VIN=12V, VOUT=3.3V, Load=1.5Ω)

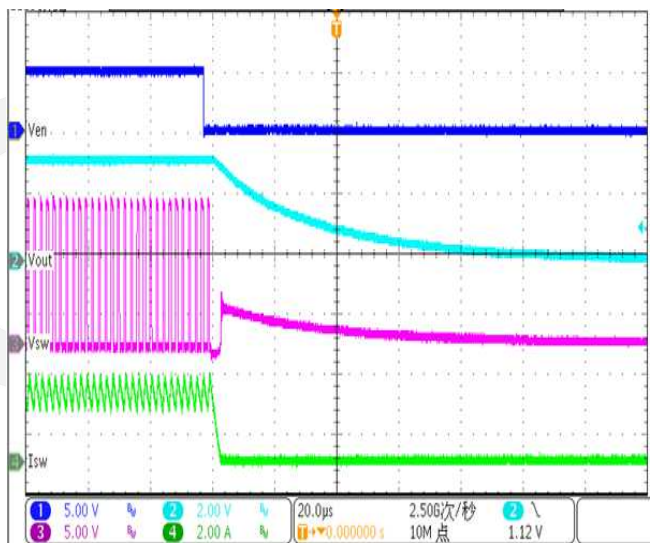

### Load Transient

( $V_{IN}=12V, V_{OUT}=3.3V, Load=0.2-2A$ )

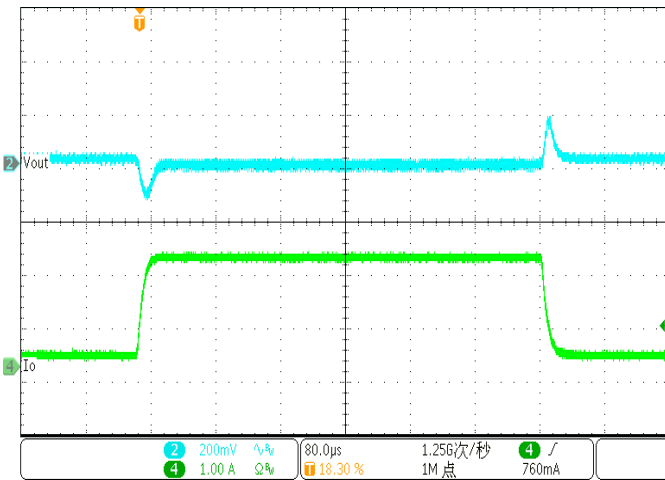

### Load Transient

( $V_{IN}=12V, V_{OUT}=3.3V, Load=1-2A$ )

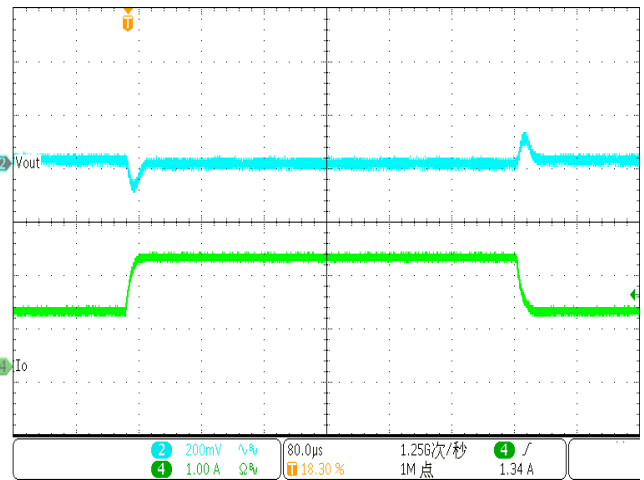

### Ripple

( $V_{IN}=12V, V_{OUT}=3.3V, Load=0A$ )

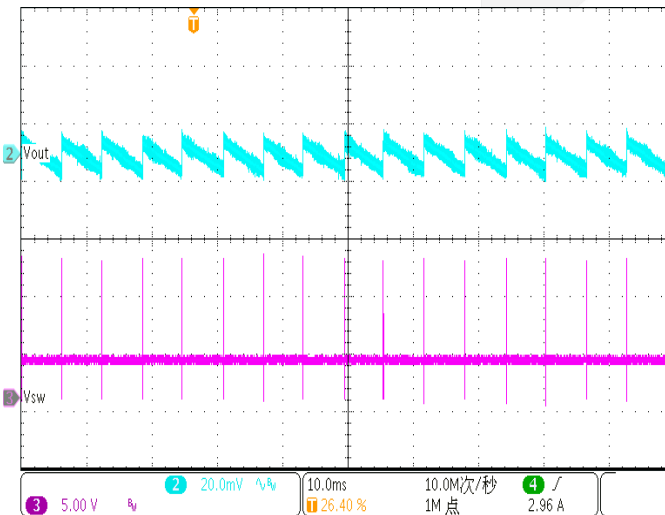

### Ripple

( $V_{IN}=12V, V_{OUT}=3.3V, Load=2A$ )

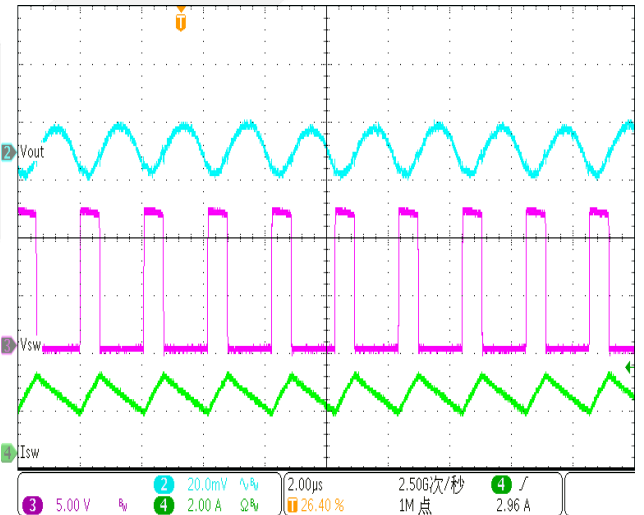

### Short Circuit Protection

( $V_{IN}=12V, V_{OUT}=3.3V, Load=2A$ )

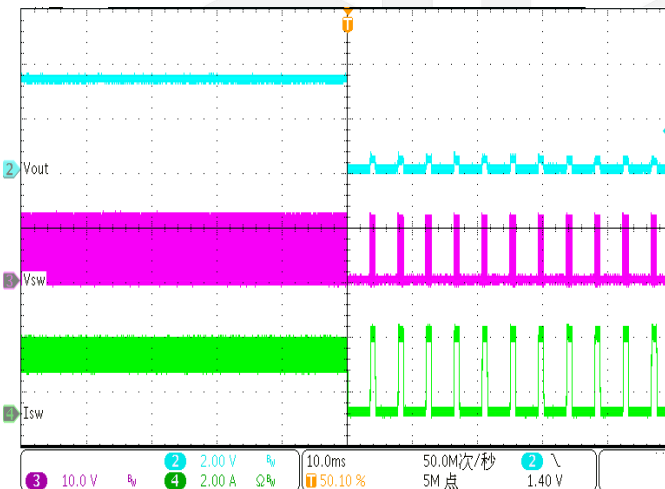

### Short Circuit Recovery

( $V_{IN}=12V, V_{OUT}=3.3V, Load=2A$ )

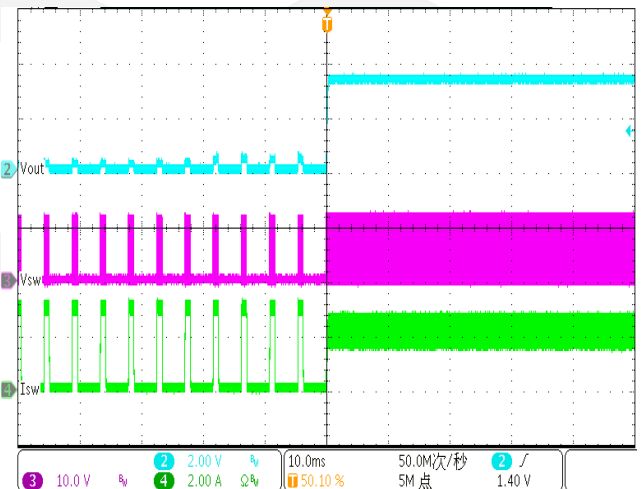

## Operation

DIO6912 is a synchronous buck regulator IC that integrates the COT control, top and bottom switches on the same die to minimize the switching transition loss and conduction loss. With ultra low  $R_{DS(ON)}$  power switches and proprietary COT control, this regulator IC can achieve the highest efficiency and the highest switch frequency simultaneously to minimize the external inductor and capacitor size, and thus achieving the minimum solution footprint.

DIO6912 provides protection functions such as cycle by cycle current limiting and thermal shutdown protection. DIO6912 will sense the output voltage conditions for the fault protection.

## Applications Information

Because of the high integration in the DIO6912 IC, the application circuit based on this regulator IC is rather simple. Only input capacitor  $C_{IN}$ , output capacitor  $C_{OUT}$ , output inductor  $L$  and feedback resistors ( $R_1$  and  $R_2$ ) need to be selected for the targeted applications specifications.

### Feedback resistor dividers $R_1$ and $R_2$

Choose  $R_1$  and  $R_2$  to program the proper output voltage. To minimize the power consumption under light loads, it is desirable to choose large resistance values for both  $R_1$  and  $R_2$ . A value of between 10k and 1M is highly recommended for both resistors. If  $V_{OUT}$  is 3.3V,  $R_1=100k$  is chosen, then  $R_2$  can be calculated to be 22.1k.

$$R_2 = \frac{0.6V}{V_{OUT} - 0.6V} R_1$$

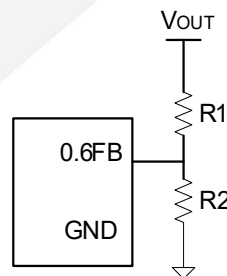

### Input capacitor $C_{IN}$

This ripple current through input capacitor is calculated as:

$$I_{CIN\_RMS} = I_{OUT} \cdot \sqrt{D(1-D)}$$

To minimize the potential noise problem, place a typical X5R or better grade ceramic capacitor really close to the IN and GND pins. Care should be taken to minimize the loop area formed by  $C_{IN}$ , and IN/GND pins. In this case, a 4.7 $\mu$ F low ESR ceramic capacitor is recommended.

### Output capacitor C<sub>OUT</sub>

The output capacitor is selected to handle the output ripple noise requirements. Both steady state ripple and transient requirements must be taken into consideration when selecting this capacitor. For the best performance, it is recommended to use X5R or better grade ceramic capacitor greater than 22μF capacitance.

### Output inductor L

There are several considerations in choosing this inductor.

- 1) Choose the inductance to provide the desired ripple current. It is suggested to choose the ripple current to be about 40% of the maximum output current. The inductance is calculated as:

$$L = \frac{V_{OUT}(1 - V_{OUT} / V_{IN, MAX})}{F_{SW} \times I_{OUT, MAX} \times 40\%}$$

where F<sub>sw</sub> is the switching frequency and I<sub>OUT,MAX</sub> is the maximum load current.

The DIO6912 regulator IC is quite tolerant of different ripple current amplitude. Consequently, the final choice of inductance can be slightly off the calculation value without significantly impacting the performance.

- 2) The saturation current rating of the inductor must be selected to be greater than the peak inductor current under full load conditions.

$$I_{SAT, MIN} > I_{OUT, MAX} + \frac{V_{OUT}(1 - V_{OUT} / V_{IN, MAX})}{2 \cdot F_{SW} \cdot L}$$

- 3) The DCR of the inductor and the core loss at the switching frequency must be low enough to achieve the desired efficiency requirement. It is desirable to choose an inductor with DCR < 50mΩ to achieve a good overall efficiency.

### External Bootstrap Cap

This capacitor provides the gate driver voltage for internal high side MOSFET. A 100nF low ESR ceramic capacitor connected between BS pin and LX pin is recommended.

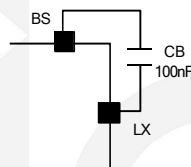

### Load Transient Considerations

The DIO6912 regulator IC integrates the compensation components to achieve good stability and fast transient responses. In some applications, adding a 22pF ceramic cap in parallel with R1 may further speed up the load transient responses and is thus recommended for applications with large load transient.

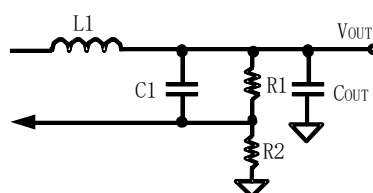



## Layout Design

The layout design of DIO6912 regulator is relatively simple. For the best efficiency and minimum noise problems, we should place the following components close to the IC:  $C_{IN}$ , L, R1 and R2.

- 1) It is desirable to maximize the PCB copper area connecting to GND pin to achieve the best thermal and noise performance. If the board space allowed, a ground plane is highly desirable.
- 2)  $C_{IN}$  must be close to Pins IN and GND. The loop area formed by  $C_{IN}$  and GND must be minimized.
- 3) The PCB copper area associated with LX pin must be minimized to avoid the potential noise problem.
- 4) The components R1 and R2, and the trace connecting to the FB pin must NOT be adjacent to the LX net on the PCB layout to avoid the noise problem.
- 5) If the system chip interfacing with the EN pin has a high impedance state at shutdown mode and the IN pin is connected directly to a power source such as a Li-Ion battery, it is desirable to add a pull down  $1M\Omega$  resistor between the EN and GND pins to prevent the noise from falsely turning on the regulator at shutdown mode.



## CONTACT US

**Dioo** is a professional design and sales corporation for high-quality and performance analog semiconductors. The company focuses on industry markets, such as, cell phone, handheld products, laptop, and medical equipment and so on. Dioo's product families include analog signal processing and amplifying, LED drivers and charger IC. Go to <http://www.dioo.com> for a complete list of Dioo product families.

For additional product information, or full datasheet, please contact with our Sales Department or Representatives.

